

FEATURES

- Output voltage up to 12 V_{pp}
- Linear amplifier
- Flat gain up to 20 GHz
- Single voltage power supply
- Low group delay variation

APPLICATIONS

- LiNbO₃ modulators
- OFDM, RoF, Phase modulation
- Research & Development

OPTIONS

- Heat-sink
- Low output voltage version for EAM

RELATED EQUIPMENTS

- MXIQER-LN, MXAN-LN modulators
- MBC-AN Automatic Bias Controllers

The DR-AN-20-HO is a wideband RF amplifier module designed for analog applications at frequencies up to 20 GHz.

The DR-AN-20-HO is characterized by a low Noise Figure and a linear transfer function whose 1 dB compression point is above 23 dBm. It exhibits flat Group Delay and Gain curves with reduced ripple over the entire bandwidth.

The DR-AN-20-HO operates from a single power supply for safety and ease of use, and offers gain control over 3 dB. The amplifier comes in a compact 52 mm x 25.6 mm housing with K type RF connectors (compatible SMA) and with an optional heat sink.

This amplifier module is ideally suited to drive optical modulators for analog applications.

Performance Highlights

Parameter	Min	Typ	Max	Unit
Cut-off frequencies	80 k	25 G	-	Hz
Output voltage	0	-	12.5	V _{pp}
Gain	-	30	-	dB
Saturated output power	26	-	-	dBm
Output power 1dB comp	22	25	-	dBm
Harmonics	-	-	-15	dBc
Noise figure	-	-	5	dB

Measurements for V_{bias} = 12 V, V_{amp} = 1.5 V, I_{bias} = 500 mA

Ordering Information:



800 Village Walk #316
Guilford, CT 06437
Ph: 203-401-8093

Email orders to: sales@xsoptix.com
Fax orders to: 800-878-7282

DC Electrical Characteristics

Parameter	Symbol	Min	Typ	Max	Unit
Supply voltage (fixed)	V_{bias}	-	12	-	V
Current consumption	I_{bias}	-	500	-	mA
Gain control voltage	V_{amp}	-	1.5	-	V

Electrical Characteristics

Parameter	Symbol	Condition	Min	Typ	Max	Unit
Lower frequency	f_{3dB} lower	-3 dB point	-	-	80	kHz
Upper frequency	f_{3dB} upper	-3 dB point	-	23	25	GHz
Gain	S_{21}	Small signal	27	29	30	dB
Gain ripple	-	$f < 24$ GHz	-	± 1.5	-	dB
Input return loss	S_{11}	$f < 20$ GHz	-	-10	-	dB
Output return loss	S_{22}	$f < 20$ GHz	-	-10	-	dB
Isolation	S_{12}	$f < 30$ GHz	-	-60	-	dB
Output power 1 dB	P_{1dB}	$2 \text{ GHz} < f < 20 \text{ GHz}$	22	25	-	dBm
Saturated power	P_{sat}	$2 \text{ GHz} < f < 20 \text{ GHz}$	26	-	-	dBm
Output voltage	V_{out}	Linear	0	-	9	V_{pp}
		Maximum swing	0	-	12.5	
Noise figure	NF	$1 \text{ GHz} < f < 18 \text{ GHz}$	2	-	5	dB
		$f < 18 \text{ GHz}$	2	-	3	
Harmonics	Harm	P1dB, $f = 5 \text{ GHz}$	-	-	-15	dBc
Power dissipation	P	Small signal	-	6	-	W

Conditions: S parameters -30 dBm, $T_{amb} = 25^\circ\text{C}$, 50 Ω system

Absolute Maximum Ratings

Stresses in excess of the absolute maximum ratings can cause permanent damage to the device. These are absolute stress ratings only. Functional operation of the device is not implied at these or any other conditions in excess of those given in the operational sections of the data sheet. Exposure to absolute maximum ratings for extended periods can adversely affect device reliability.

Parameter	Symbol	Min	Max	Unit
RF input voltage	V_{in}	-	0.9	V_{pp}
Supply Voltage	V_{bias}	11	13	V
DC current	I_{bias}	-	0.560	mA
Gain control voltage	V_{amp}	0	2	V
Power dissipation	P_{diss}	-	7.3	W
Temperature of operation	T_{op}	0	+40	$^\circ\text{C}$
Storage temperature	T_{st}	-5	+70	$^\circ\text{C}$

S_{21} and Group Delay Parameter Curves

Conditions: $V_{bias} = 12\text{ V}$, $V_{amp} = 1.5\text{ V}$, $I_{bias} = 500\text{ mA}$

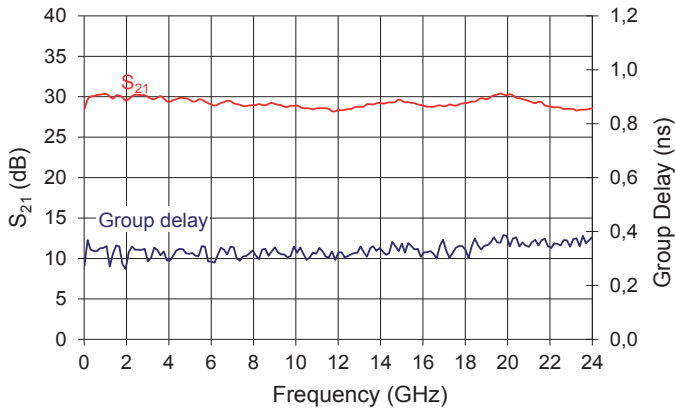

S_{12} Parameter Curve

Conditions: $V_{bias} = 12\text{ V}$, $V_{amp} = 1.5\text{ V}$, $I_{bias} = 500\text{ mA}$

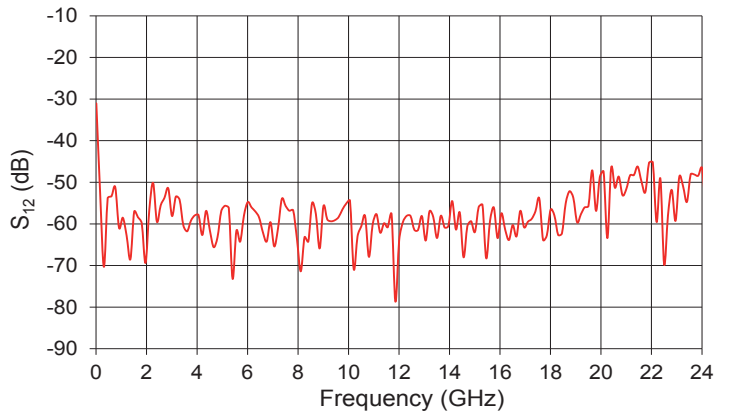

S_{22} Parameter Curve

Conditions: $V_{bias} = 12\text{ V}$, $V_{amp} = 1.5\text{ V}$, $I_{bias} = 500\text{ mA}$

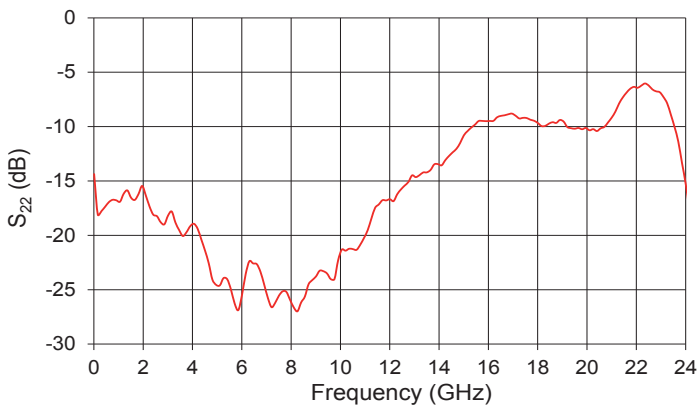

S_{11} Parameter Curve

Conditions: $V_{bias} = 12\text{ V}$, $V_{amp} = 1.5\text{ V}$, $I_{bias} = 500\text{ mA}$

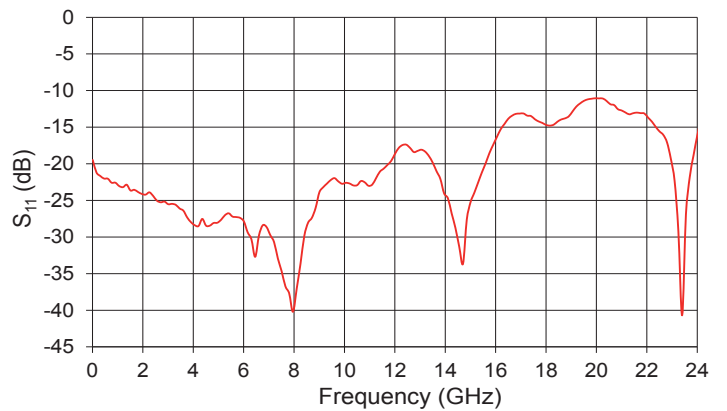

1dB Compression Curve

Conditions: $V_{bias} = 12\text{ V}$, $V_{amp} = 1.5\text{ V}$, $I_{bias} = 500\text{ mA}$

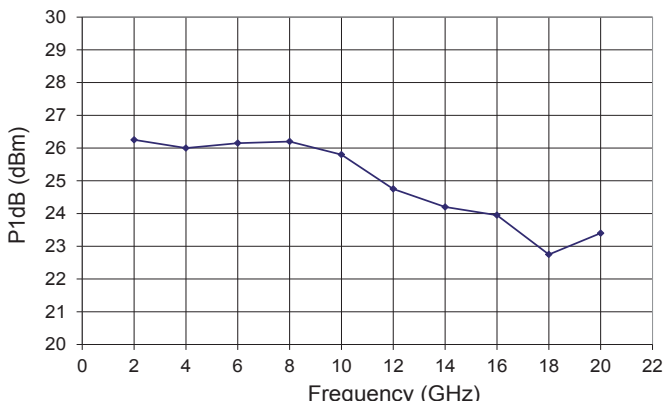

Noise Figure Curve

Conditions: $V_{bias} = 12\text{ V}$, $V_{amp} = 1.5\text{ V}$, $I_{bias} = 500\text{ mA}$

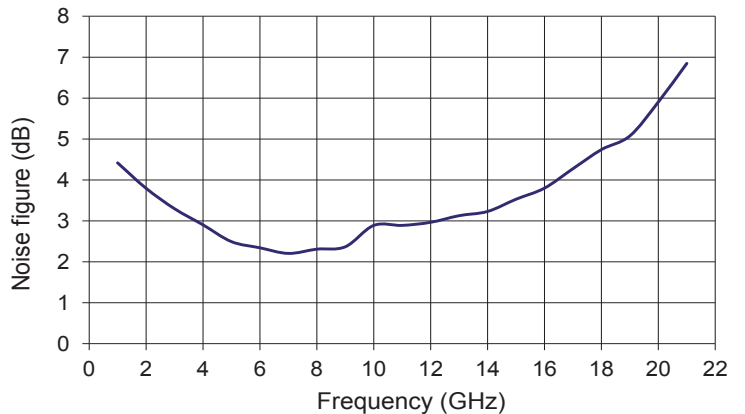

Electrical Schematic Diagram

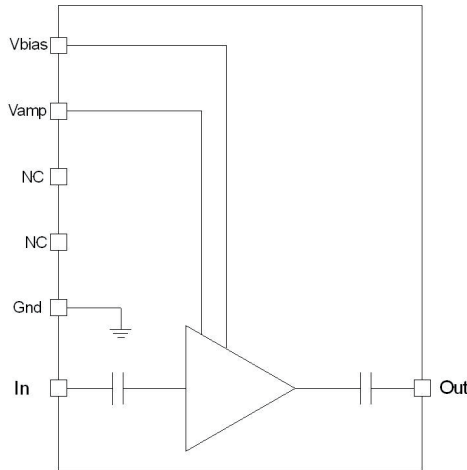

Mechanical Diagram and Pinout

All measurements in mm

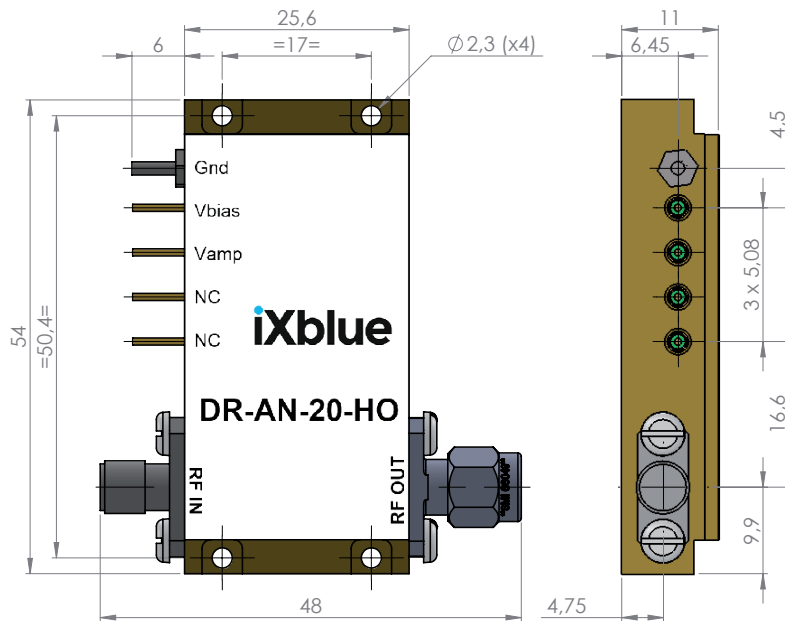

The heatsinking of the module is necessary. It's user responsibility to use an adequate heatsink. Refer to page 5 for ixBlue recommended heatsink.

PIN	Function	Unit
IN	RF In	Kconnector female
OUT	RF Out	K connector male
V_{bias}	Power supply voltage	Set a typical operating specification
V_{amp}	Output voltage amplitude adjustment	Adjust for gain control tuning

Mechanical Diagram And Pinout With HS-HO1 Heatsink

All measurements in mm

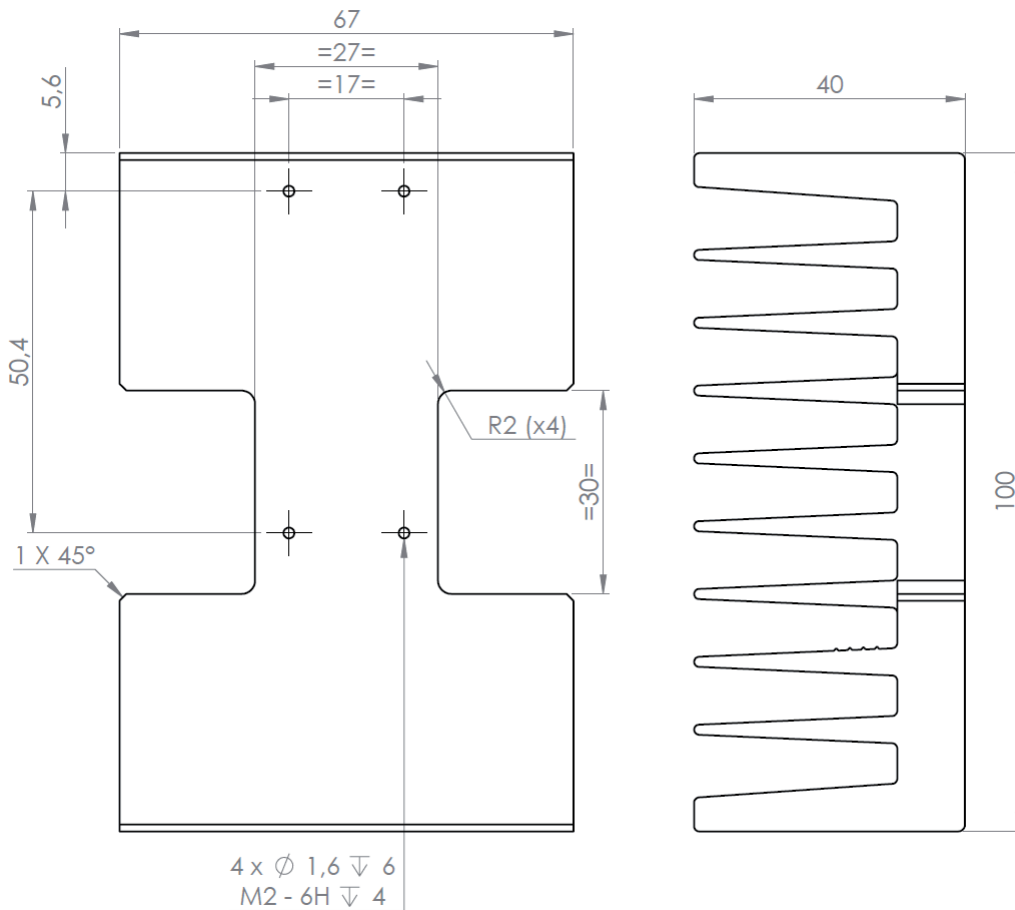
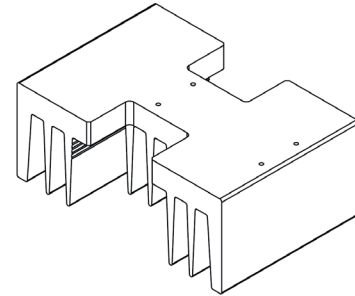

About us

ixBlue Photonics produces specialty optical fibers and Bragg gratings based fiber optics components and provides optical modulation solutions based on the company lithium niobate (LiNbO₃) modulators and RF electronic modules.

ixBlue Photonics serves a wide range of industries: sensing and instruments, defense, telecommunications, space and fiber lasers as well as research laboratories all over the world.

3, rue Sophie Germain
 25 000 Besançon - FRANCE
 Tel. : +33 (0) 381 853 180 - Fax : + 33 (0) 381 811 557

ixblue reserves the right to change, at any time and without notice, the specifications, design, function or form of its products described herein. All statements, specification, technical information related to the products herein are given in good faith and based upon information believed to be reliable and accurate at the moment of printing. However the accuracy and completeness thereof is not guaranteed. No liability is assumed for any inaccuracies and as a result of use of the products. The user must validate all parameters for each application before use and he assumes all risks in connection with the use of the products