

EYP-TBR-1064-02000-6000-BFW09-0000

Revision 0.70

14.01.2022

SINGLE FREQUENCY LASER DIODES

Distributed Bragg Reflector Laser with integrated Amplifier

General Product Information

Product	Application
1064 nm DBR Laser	Raman Spectroscopy
with monolithically integrated Tapered Amplifier (TA)	Metrology
hermetic 14 Pin Butterfly Housing (RoHS compliant)	Nd:YAG Replacement
including Thermoelectric Cooler and Thermistor	EDFA Pumping

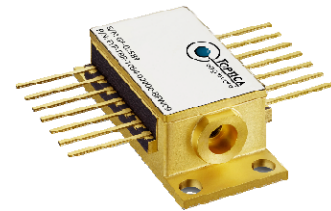
Absolute Maximum Ratings

Parameter	Symbol	Unit	min	typ	max
Storage Temperature	T_S	°C	-40		85
Operational Temperature at Case	T_C	°C	-20		75
Operational Temperature at Laser Chip	T_{LD}	°C	10		50
Forward Current DBR	I_{DBR}	mA			500
Forward Current TA	I_{TA}	A			7.5
Reverse Voltage DBR	$V_{R,DBR}$	V			2
Reverse Voltage TA	$V_{R,TA}$	V			2
Output Power	P_{opt}	W			2.5
TEC Current	I_{TEC}	A			2.5
TEC Voltage	V_{TEC}	V			5.0

Measurement Conditions / Comments

Stress in excess of one of the Absolute Maximum Ratings may damage the laser. Please note that a damaging optical power level may occur although the maximum current is not reached. These are stress ratings only, and functional operation at these or any other conditions beyond those indicated under Recommended Operational Conditions is not implied.

Recommended Operational Conditions

Parameter	Symbol	Unit	min	typ	max
Operational Temperature at Case	T_C	°C	0		50
Operational Temperature at Laser Chip	T_{LD}	°C	15	25	35
Forward Current DBR	I_{DBR}	mA			450
Forward Current TA	I_{TA}	A			7.0
Output Power	P_{opt}	W			2.0

Measurement Conditions / Comments

Characteristics

Parameter	Symbol	Unit	min	typ	max
Center Wavelength	λ_C	nm	1063	1064	1065
Spectral Width (FWHM)	$\Delta\lambda$	pm		3	
Sidemode Suppression Ratio	SMSR	dB	30		

Measurement Conditions / Comments

see images on page 4

apart from mode-hops (see Spectral Map on page 4)

$P_{opt} = 2$ W

EYP-TBR-1064-02000-6000-BFW09-0000

Revision 0.70

14.01.2022

SINGLE FREQUENCY LASER DIODES

Distributed Bragg Reflector Laser with integrated Amplifier

Characteristics cont'd

Parameter	Symbol	Unit	min	typ	max
Temperature Coefficient of Wavelength	$d\lambda / dT$	nm / K		0.08	
Current Coefficient of Wavelength	$d\lambda / dI_{DBR}$	nm / mA		0.001	
Current Coefficient of Wavelength	$d\lambda / dI_{TA}$	nm / A		0.035	
Laser Current @ $P_{opt} = 2.0$ W	I_{TA}	A			7.0
Slope Efficiency	η	W / A		0.8	
Threshold Current	$I_{th, TA}$	A		3	
Divergence parallel (FWHM)	$\Theta_{ }$	mrad		2	
Divergence perpendicular (FWHM)	Θ_{\perp}	mrad		2	
Beam Diameter horizontal ($1/e^2$)	$d_{ }$	mm		1	
Beam Diameter vertical ($1/e^2$)	d_{\perp}	mm		1	
Degree of Polarization	DOP	%		90	

Measurement Conditions / Comments

Laser Forward Current DBR

Laser Forward Current TA

Amplifier

parallel to the base plate of the housing (see p. 3)

perpendicular to base plate of the housing (see p. 3)

parallel to the base plate of the housing (see p. 3)

perpendicular to base plate of the housing (see p. 3)

 $P_{opt} = 2$ W; E field parallel to the base plate

Thermoelectric Cooler

Parameter	Symbol	Unit	min	typ	max
Current	I_{TEC}	A			2.5
Voltage	U_{TEC}	V			5.0
Power Dissipation (total loss at case)	P_{loss}	W		10	
Temperature Difference	ΔT	K			25

Measurement Conditions / Comments

 $P_{opt} = 2$ W, $\Delta T = 20$ K $P_{opt} = 2$ W, $\Delta T = 20$ K $P_{opt} = 2$ W, $\Delta T = 20$ K $P_{opt} = 2$ W, $\Delta T = |T_{case} - T_{LD}|$

Thermistor (Standard NTC Type)

Parameter	Symbol	Unit	min	typ	max
Resistance	R	k Ω		10	
Beta Coefficient	β			3892	
Steinhart & Hart Coefficient A	A			1.1293×10^{-3}	
Steinhart & Hart Coefficient B	B			2.3410×10^{-4}	
Steinhart & Hart Coefficient C	C			8.7755×10^{-8}	

Measurement Conditions / Comments

 $T_{LD} = 25^{\circ}$ C $R_1 / R_2 = e^{\beta(1/T_1 - 1/T_2)}$ at $T_{LD} = 0^{\circ} \dots 50^{\circ}$ C $1/T = A + B(\ln R) + C(\ln R)^3$

T: temperature in Kelvin

R: resistance at T in Ohm

Ordering Information:



800 Village Walk #316
 Guilford, CT 06437
 Ph: 203-401-8093

Email orders to: sales@xsoptix.com
 Fax orders to: 800-878-7282

EYP-TBR-1064-02000-6000-BFW09-0000

Revision 0.70

14.01.2022

SINGLE FREQUENCY LASER DIODES Distributed Bragg Reflector Laser with integrated Amplifier

Pin Assignment

1	Thermoelectric Cooler (+)	14	Thermoelectric Cooler (-)
2	Thermistor	13	Case
3	Thermistor	12	Amplifier (Anode)
4	Laser and Amplifier (Cathode)	11	Amplifier (Anode)
5	Laser and Amplifier (Cathode)	10	Amplifier (Anode)
6	Laser and Amplifier (Cathode)	9	Amplifier (Anode)
7	Laser and Amplifier (Cathode)	8	Laser (Anode)

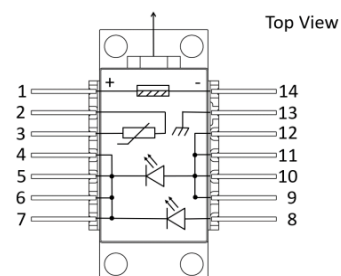

Package Drawings

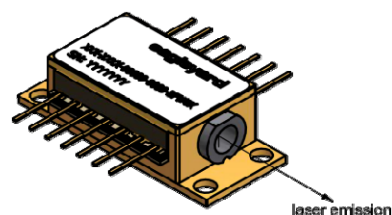
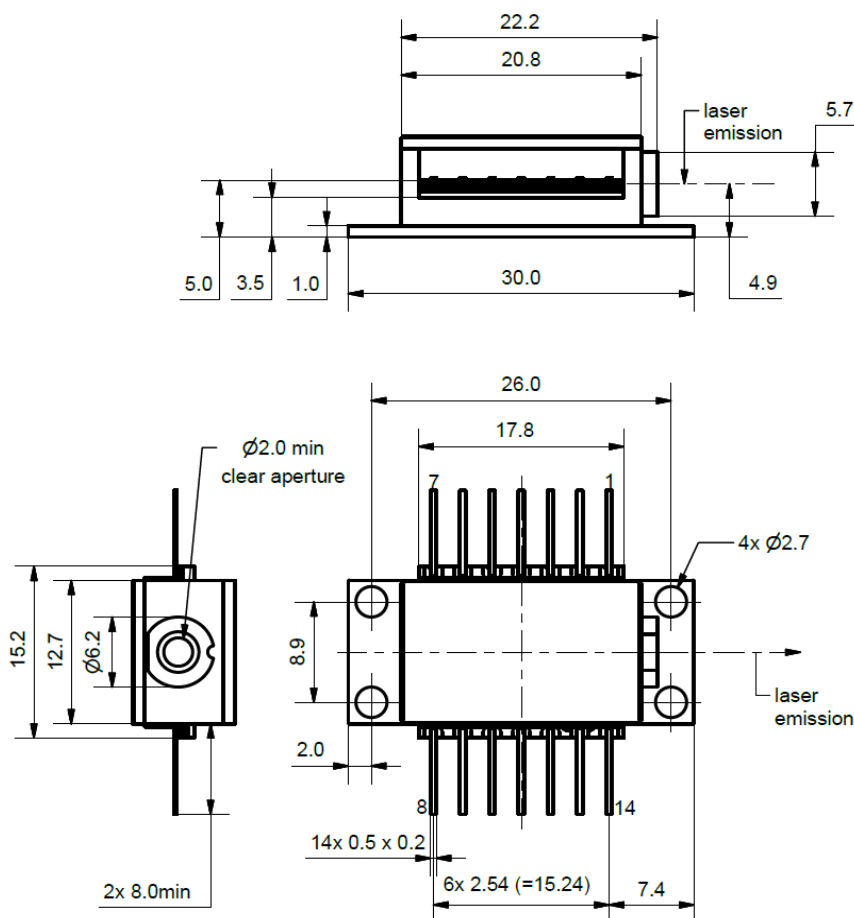

Caution. Excessive mechanical stress on the package can lead to a damage of the laser.

See [instruction manual](http://www.eagleyard.com) on www.eagleyard.com

AIZ-15-0729-0947C

EYP-TBR-1064-02000-6000-BFW09-0000

Revision 0.70

14.01.2022

SINGLE FREQUENCY LASER DIODES Distributed Bragg Reflector Laser with integrated Amplifier

Typical Measurement Results

Spectral Map

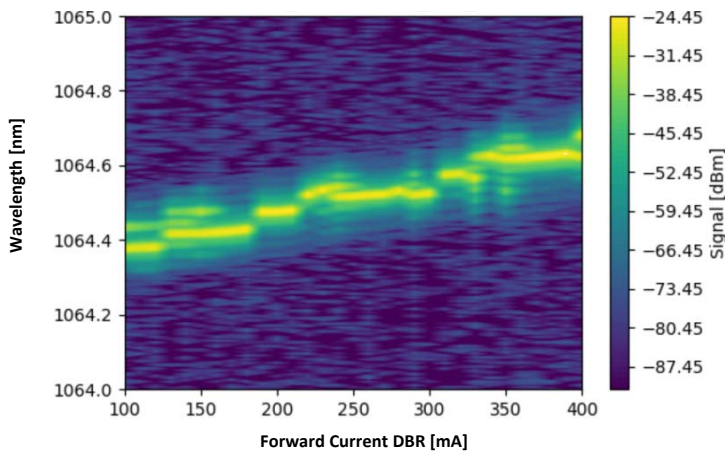

Performance figures, data and any illustrative material provided in this specification are typical and must be specifically confirmed in writing by eagleyard Photonics before they become applicable to any particular order or contract. In accordance with the eagleyard Photonics policy of continuous improvement specifications may change without notice.

Unpacking, Installation and Laser Safety

Unpacking the laser diodes should only be done at electrostatic safe workstations (EPA). Though protection against electro static discharge (ESD) is implemented in the laser package, charges may occur at surfaces. Please store this product in its original package at a dry, clean place until final use. During device installation, ESD protection has to be maintained.

The TBR laser is sensitive against optical feedback, so an optical isolator may be required in order to avoid any disturbance of the emission spectrum. Operating at moderate temperatures on proper heat sinks will contribute to a long lifetime of the diode.

Avoid direct and/or indirect exposure to the free running beam. Collimating and focussing the free running beam with optics as common in optical instruments will increase threat to the human eye.

Performance figures, data and any illustrative material provided in this specification are typical and must be specifically confirmed in writing by eagleyard Photonics before they become applicable to any particular order or contract. In accordance with the eagleyard Photonics policy of continuous improvement specifications may change without notice.

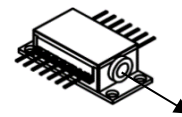

Laser Emission

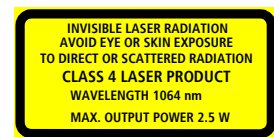

IEC-60825-0



Complies with 21 CFR 1040.10 and 1040.40