

EYP-RWE-0840-06515-1500-SOT02-0000

Revision 1.10

24.01.2018

GAIN CHIPS AR coated Fabry-Perot Laser



General Product Information

Product	Application
widely tunable 840 nm modified Fabry-Perot Laser	Spectroscopy
for use in an External Cavity Diode Laser (ECDL)	covering wavelengths
sealed SOT Housing	between 790 and 870 nm
Monitor Diode	



Absolute Maximum Ratings

Parameter	Symbol	Unit	min	typ	max
Storage Temperature	T_S	°C	-40		85
Operational Temperature at Case	T_C	°C	-20		50
Forward Current	I_F	mA			200
Reverse Voltage	V_R	V			0
Output Power (extracavity)	P_{opt}	mW			100

Measurement Conditions / Comments

Stress in excess of one of the Absolute Maximum Ratings can cause permanent damage to the device. Please note that a damaging optical power level may occur although the maximum current is not reached.

Recommended Operational Conditions

Parameter	Symbol	Unit	min	typ	max
Operational Temperature at Case	T_C	°C	15		40
Forward Current	I_F	mA			180
Output Power (extracavity)	P_{opt}	mW			80

Measurement Conditions / Comments

Characteristics at 25° C at Begin Of Life

Parameter	Symbol	Unit	min	typ	max
Center Wavelength	λ_C	nm		840	
Tuning Range	$\Delta\lambda_{tun}$	nm	790		870
Output Power (extracavity)	P_{opt}	mW		50	
Cavity Length	L	μm		1500	
Reflectivity at Front Facet	R_{ff}			$3 \cdot 10^{-4}$	$1 \cdot 10^{-3}$
Polarization				TE	
Spatial Mode (transversal) TEM ₀₀					
Spectral Mode (longitudinal)				Single/Multi Mode	
Divergence parallel (FWHM)	$\Theta_{ }$	°		10	
Divergence perpendicular (FWHM)	Θ_{\perp}	°		23	

Measurement Conditions / Comments

Tuning range and output power are estimated from the gain profile of the laser. The actual achieved wavelength and power are strongly influenced by the external cavity. Therefore eagleyard Photonics will give no guarantee on these parameters.

E field parallel to Pin 2 - Pin 3 - plane

Fundamental Mode

depending on operating conditions

parallel to Pin 2 - Pin 3 plane (see p. 3)

perpendicular to Pin 2 - Pin 3 plane (see p. 3)

EYP-RWE-0840-06515-1500-SOT2-0000

Revision 1.10

24.01.2018

GAIN CHIPS AR coated Fabry-Perot Laser



Monitor Diode

Parameter	Symbol	Unit	min	typ	max
Monitor Detector Responsivity ($U_{R,MD} = 5\text{ V}$)	I_{mon} / P_{opt}	$\mu\text{A} / \text{mW}$		20	

Measurement Conditions / Comments
depends on the intracavity power of the ECDL setup

Package Dimensions

Parameter	Symbol	Unit	min	typ	max
Height of Emission Plane	d_{EP}	mm	3.50	3.65	3.70
Excentricity of Emission Center	R	mm			0.12
Pin Length	l_{PIN}	mm		14	

Measurement Conditions / Comments
reference plane: top side of TO header
reference: center of outer diameter of header

Package Pinout

M-type

- 1 Laser Diode Cathode, Monitor Diode Cathode, Case
- 2 Photo Diode Anode
- 3 Laser Diode Anode

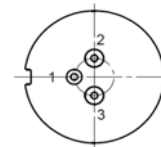
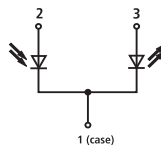

Package Drawings

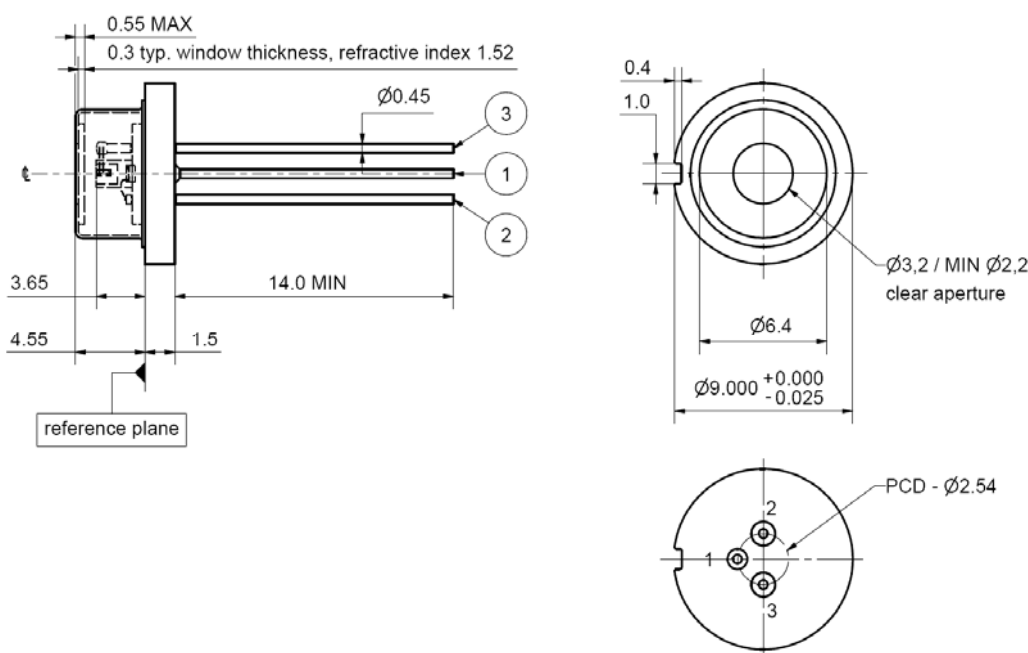

EYP-RWE-0840-06515-1500-SOT02-0000

Revision 1.10

24.01.2018

GAIN CHIPS AR coated Fabry-Perot Laser



Typical Measurement Results ex cavity

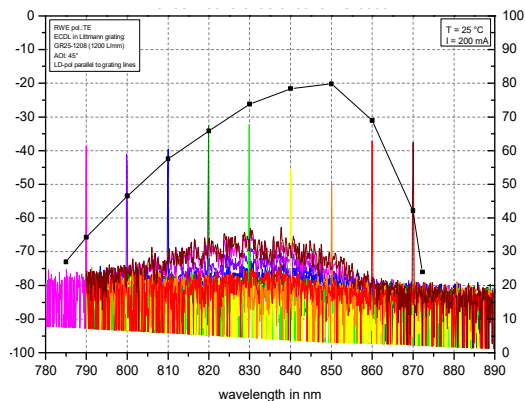
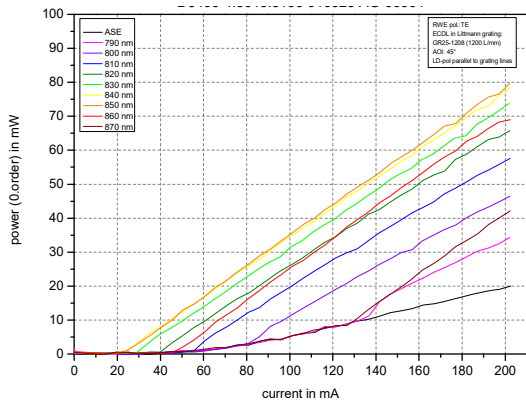

Unpacking, Installation and Laser Safety

Unpacking the laser diodes should only be done at electrostatic safe workstations (EPA). Though protection against electro static discharge (ESD) is implemented in the laser package, charges may occur at surfaces. Please store this product in its original package at a dry, clean place until final use. During device installation, ESD protection has to be maintained.

The RWE diode type is known to be sensitive against thermal stress. It should not be operated without appropriate optical feedback from an external cavity. Operating at moderate temperatures on proper heat sinks will contribute to a long lifetime of the diode.

The laser emission from this diode is close to the invisible infrared region of the electromagnetic spectrum. Avoid direct and/or indirect exposure to the free running beam. Collimating the free running beam with optics as common in optical instruments will increase threat to the human eye.

Each laser diode will come with an individual test protocol verifying the parameters given in this document.

Performance figures, data and any illustrative material provided in this specification are typical and must be specifically confirmed in writing by eagleyard Photonics before they become applicable to any particular order or contract. In accordance with the eagleyard Photonics policy of continuous improvement specifications may change without notice.

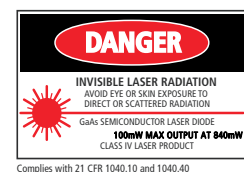
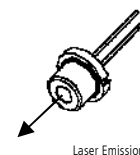

Ordering Information:



800 Village Walk #316
Guilford, CT 06437
Ph: 203-401-8093

Email orders to: sales@xsoptix.com
Fax orders to: 800-878-7282

