

EYP-DFB-1083-00080-1500-BFW01-0002

Revision 0.52

2017-03-02

SINGLE FREQUENCY LASER DIODES Distributed Feedback Laser

General Product Information

Product	Application
Tunable 1083 nm DFB Laser	Spectroscopy
with hermetic 14 Pin-Butterfly Housing (RoHS compliant)	Metrology
including Monitor Diode, Thermoelectric Cooler and Thermistor	Magnetometer
with integrated Beam Collimation	

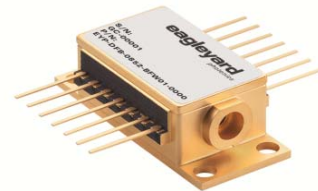

Absolute Maximum Ratings

Parameter	Symbol	Unit	min	typ	max
Storage Temperature	T_S	°C	-40		85
Operational Temperature at Case	T_C	°C	-40		85
Operational Temperature at Laser Chip	T_{LD}	°C	10		50
Forward Current	I_F	mA			200
Reverse Voltage	V_R	V			2
Output Power	P_{opt}	mW			90
TEC Current	I_{TEC}	A			1.1
TEC Voltage	V_{TEC}	V			2.8

Measurement Conditions / Comments

Stress in excess of one of the Absolute Maximum Ratings may damage the laser. Please note that a damaging optical power level may occur although the maximum current is not reached. These are stress ratings only, and functional operation at these or any other conditions beyond those indicated under Recommended Operational Conditions is not implied.

Recommended Operational Conditions

Parameter	Symbol	Unit	min	typ	max
Operational Temperature at Case	T_{case}	°C	-20		65
Operational Temperature at Laser Chip	T_{LD}	°C	15		40
Forward Current	I_F	mA			190
Output Power	P_{opt}	mW	20		80

Measurement Conditions / Comments

measured by integrated Thermistor

Characteristics at $T_{LD} = 25^\circ$ at BOL

Parameter	Symbol	Unit	min	typ	max
Center Wavelength	λ_c	nm	1082	1083	1084
Linewidth (FWHM)	$\Delta\lambda$	MHz		2	
Mode-hop free Tuning Range	$\Delta\lambda_{tune}$	pm		1500	
Sidemode Suppression Ratio	SMSR	dB	30	45	
Temperature Coefficient of Wavelength	$d\lambda / dT$	nm / K		0.06	
Current Coefficient of Wavelength	$d\lambda / dI$	nm / mA		0.003	

Measurement Conditions / Comments

see images on page 4

reached by temperature modulation

$P_{opt} = 80$ mW

EYP-DFB-1083-00080-1500-BFW01-0002

Revision 0.52

2017-03-02

SINGLE FREQUENCY LASER DIODES Distributed Feedback Laser



Characteristics at $T_{LD} = 25^\circ$ at BOL cont'd

Parameter	Symbol	Unit	min	typ	max
Mode-hop free Temperature Range	T_{LD}	$^\circ\text{C}$	15		40
Mode-hop free Power Range	P_{opt}	mW	20		80
Laser Current @ $P_{opt} = 80\text{ mW}$	I_{LD}	mA			190
Slope Efficiency	η	W / A	0.6	0.8	1.0
Threshold Current	I_{th}	mA			70
Divergence parallel (FWHM)	$\Theta_{ }$	$^\circ$		0.1	
Divergence perpendicular (FWHM)	Θ_{\perp}	$^\circ$		0.1	
Beam Diameter horizontal ($1/e^2$)	$d_{ }$	mm		1.0	1.2
Beam Diameter vertical ($1/e^2$)	d_{\perp}	mm		0.8	1.2
Degree of Polarization	DOP	%		90	

Measurement Conditions / Comments

temperature measured by integrated themistor

parallel to the base plate of the housing (see p. 3)
perpendicular to base plate of the housing (see p. 3)
parallel to the base plate of the housing (see p. 3)
perpendicular to base plate of the housing (see p. 3)
 $P_{opt} = 80\text{ mW}$; E field parallel to the base plate

Monitor Diode

Parameter	Symbol	Unit	min	typ	max
Monitor Detector Responsivity	I_{mon} / P_{opt}	$\mu\text{A/mW}$	0.05		10

Measurement Conditions / Comments

 $U_R = 5\text{ V}$

Thermoelectric Cooler

Parameter	Symbol	Unit	min	typ	max
Current	I_{TEC}	A		0.4	
Voltage	U_{TEC}	V		0.8	
Power Dissipation (total loss at case)	P_{loss}	W		0.4	
Temperature Difference	ΔT	K			50

Measurement Conditions / Comments

 $P_{opt} = 80\text{ mW}$, $\Delta T = 20\text{ K}$ $P_{opt} = 80\text{ mW}$, $\Delta T = 20\text{ K}$ $P_{opt} = 80\text{ mW}$, $\Delta T = 20\text{ K}$ $P_{opt} = 80\text{ mW}$, $\Delta T = |T_{case} - T_{LD}|$

Thermistor (Standard NTC Type)

Parameter	Symbol	Unit	min	typ	max
Resistance	R	$k\Omega$		10	
Beta Coefficient	β			3892	
Steinhart & Hart Coefficient A	A			1.1293×10^{-3}	
Steinhart & Hart Coefficient B	B			2.3410×10^{-4}	
Steinhart & Hart Coefficient C	C			8.7755×10^{-8}	

Measurement Conditions / Comments

 $T_{LD} = 25^\circ\text{C}$ $R_1 / R_2 = e^{\beta(1/T_1 - 1/T_2)}$ at $T_{LD} = 0^\circ \dots 50^\circ\text{C}$ $1/T = A + B(\ln R) + C(\ln R)^3$

T: temperature in Kelvin

R: resistance at T in Ohm

EYP-DFB-1083-00080-1500-BFW01-0002

Revision 0.52

2017-03-02

SINGLE FREQUENCY LASER DIODES Distributed Feedback Laser

Pin Assignment

1	Thermoelectric Cooler (+)	14	Thermoelectric Cooler (-)
2	Thermistor	13	Case
3	Photodiode (Anode)	12	not connected
4	Photodiode (Cathode)	11	Laser Diode (Cathode)
5	Thermistor	10	Laser Diode (Anode)
6	not connected	9	not connected
7	not connected	8	not connected

Pins are isolated from case unless noted otherwise.

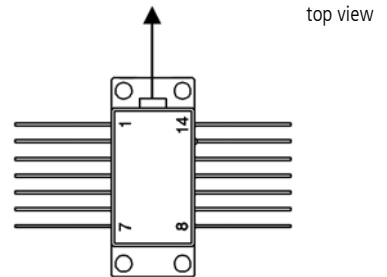

Package Drawings

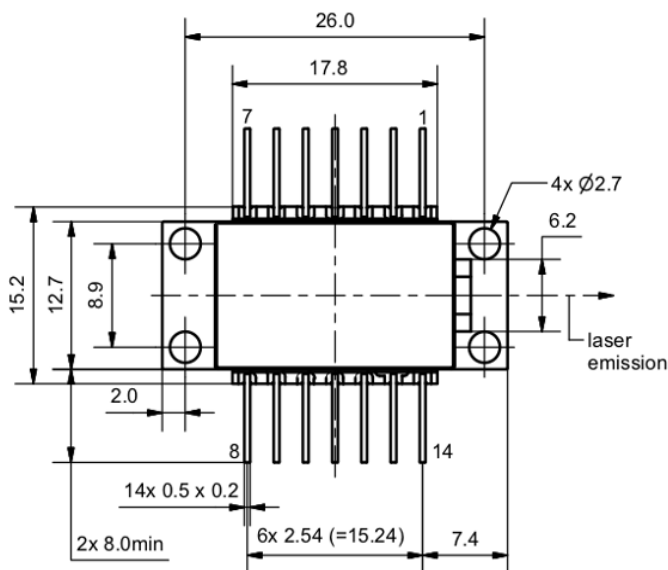
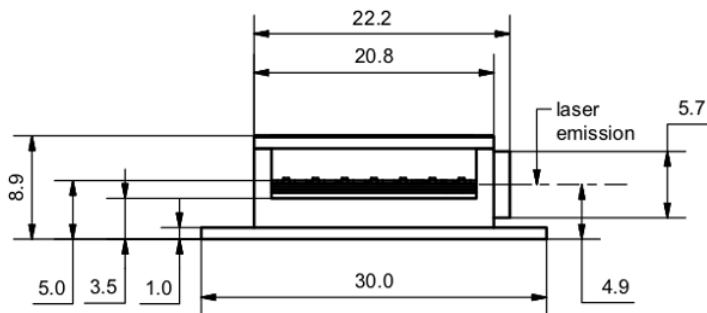

AIZ-15-0729-0947

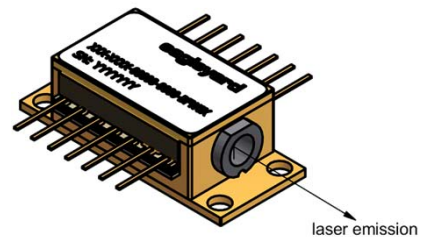

EYP-DFB-1083-00080-1500-BFW01-0002

Revision 0.52

2017-03-02

SINGLE FREQUENCY LASER DIODES Distributed Feedback Laser

Typical Measurement Results

Output Power vs. Current

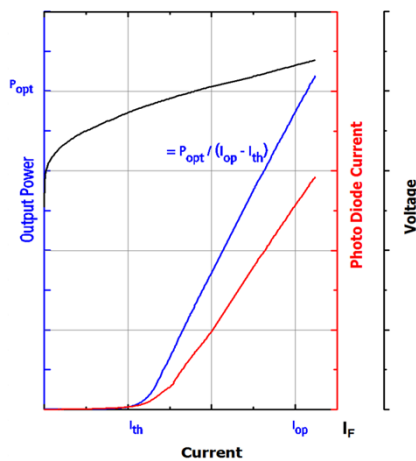

Spectra at Specified Optical Output Power



Performance figures, data and any illustrative material provided in this specification are typical and must be specifically confirmed in writing by eagleyard Photonics before they become applicable to any particular order or contract. In accordance with the eagleyard Photonics policy of continuous improvement specifications may change without notice.

Ordering Information:



800 Village Walk #316
Guilford, CT 06437
Ph: 203-401-8093

Email orders to: sales@xsoptix.com
Fax orders to: 800-878-7282

Unpacking, Installation and Laser Safety

Unpacking the laser diodes should only be done at electrostatic safe workstations (EPA). Though protection against electro static discharge (ESD) is implemented in the laser package, charges may occur at surfaces. Please store this product in its original package at a dry, clean place until final use. During device installation, ESD protection has to be maintained.

The DFB laser is sensitive against optical feedback, so an optical isolator may be required in order to avoid any disturbance of the emission spectrum. Operating at moderate temperatures on proper heat sinks will contribute to a long lifetime of the diode.

Avoid direct and/or indirect exposure to the free running beam. Collimating and focussing the free running beam with optics as common in optical instruments will increase threat to the human eye.

Performance figures, data and any illustrative material provided in this specification are typical and must be specifically confirmed in writing by eagleyard Photonics before they become applicable to any particular order or contract. In accordance with the eagleyard Photonics policy of continuous improvement specifications may change without notice.

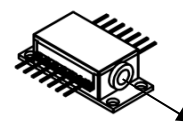

Laser Emission



IEC-60825-0

