

# EYP-DFB-0767-00050-1500-BFW01-0002

Revision 0.92

2018-01-19

## SINGLE FREQUENCY LASER DIODES Distributed Feedback Laser

### General Product Information

Product	Application
767 nm DFB Laser	Spectroscopy
with hermetic 14-Pin Butterfly Housing (ROHS compliant)	Metrology
including Monitor Diode, Thermoelectric Cooler and Thermistor	
with integrated Beam Collimation	

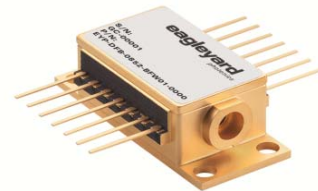

### Absolute Maximum Ratings

Parameter	Symbol	Unit	min	typ	max
Storage Temperature	$T_S$	°C	-40		85
Operational Temperature at Case	$T_C$	°C	-40		85
Operational Temperature at Laser Chip	$T_{LD}$	°C	10		50
Forward Current	$I_F$	mA			140
Reverse Voltage	$V_R$	V			2
Output Power	$P_{opt}$	mW			60
TEC Current	$I_{TEC}$	A			1.8
TEC Voltage	$V_{TEC}$	V			2.8

### Measurement Conditions / Comments

Stress in excess of one of the Absolute Maximum Ratings may damage the laser. Please note that a damaging optical power level may occur although the maximum current is not reached. These are stress ratings only, and functional operation at these or any other conditions beyond those indicated under Recommended Operational Conditions is not implied.

### Recommended Operational Conditions

Parameter	Symbol	Unit	min	typ	max
Operational Temperature at Case	$T_{case}$	°C	-20		65
Operational Temperature at Laser Chip	$T_{LD}$	°C	15		35
Forward Current	$I_F$	mA			130
Output Power	$P_{opt}$	mW	10		50

### Measurement Conditions / Comments

measured by integrated Thermistor

ex fiber

### Characteristics at $T_{LD} = 25^\circ$ at BOL

Parameter	Symbol	Unit	min	typ	max
Center Wavelength	$\lambda_c$	nm	766	767	768
Linewidth (FWHM)	$\Delta\lambda$	MHz		2	
Mode-hop free Tuning Range	$\Delta\lambda_{tune}$	pm		1200	
Sidemode Suppression Ratio	SMSR	dB	30	50	
Temperature Coefficient of Wavelength	$d\lambda / dT$	nm / K		0.06	
Current Coefficient of Wavelength	$d\lambda / dI$	nm / mA		0.003	

### Measurement Conditions / Comments

see images on page 4

reached by temperature modulation

$P_{opt} = 50$  mW

# EYP-DFB-0767-00050-1500-BFW01-0002

Revision 0.92

2018-01-19

## SINGLE FREQUENCY LASER DIODES Distributed Feedback Laser



### Characteristics at $T_{LD} = 25^\circ$ at BOL cont'd

Parameter	Symbol	Unit	min	typ	max
Mode-hop free Temperature Range	$T_{LD}$	$^\circ\text{C}$	15		35
Mode-hop free Power Range	$P_{opt}$	mW	10		50
Laser Current @ $P_{opt} = 50$ mW	$I_{LD}$	mA			130
Slope Efficiency	$\eta$	W / A		0.9	
Threshold Current	$I_{th}$	mA			70
Divergence parallel (FWHM)	$\Theta_{  }$	$^\circ$		0.1	
Divergence perpendicular (FWHM)	$\Theta_{\perp}$	$^\circ$		0.1	
Beam Diameter horizontal ( $1/e^2$ )	$d_{  }$	mm		1.0	1.2
Beam Diameter vertical ( $1/e^2$ )	$d_{\perp}$	mm		0.8	1.2
Degree of Polarization	DOP	%		60	

### Measurement Conditions / Comments

parallel to the base plate of the housing (see p. 3)  
perpendicular to base plate of the housing (see p. 3)  
parallel to the base plate of the housing (see p. 3)  
perpendicular to base plate of the housing (see p. 3)  
 $P_{opt} = 50$  mW; E field perpendicular to the base plate

### Monitor Diode

Parameter	Symbol	Unit	min	typ	max
Monitor Detector Responsivity	$I_{mon} / P_{opt}$	$\mu\text{A}/\text{mW}$	0.5		40

### Measurement Conditions / Comments

$U_R = 5$  V

### Thermoelectric Cooler

Parameter	Symbol	Unit	min	typ	max
Current	$I_{TEC}$	A		0.4	
Voltage	$U_{TEC}$	V		0.8	
Power Dissipation (total loss at case)	$P_{loss}$	W		0.4	
Temperature Difference	$\Delta T$	K			50

### Measurement Conditions / Comments

$P_{opt} = 50$  mW,  $\Delta T = 20$  K  
 $P_{opt} = 50$  mW,  $\Delta T = 20$  K  
 $P_{opt} = 50$  mW,  $\Delta T = 20$  K  
 $P_{opt} = 50$  mW,  $\Delta T = |T_{case} - T_{LD}|$

### Thermistor (Standard NTC Type)

Parameter	Symbol	Unit	min	typ	max
Resistance	R	$k\Omega$		10	
Beta Coefficient	$\beta$			3892	
Steinhart & Hart Coefficient A	A			$1.1293 \times 10^{-3}$	
Steinhart & Hart Coefficient B	B			$2.3410 \times 10^{-4}$	
Steinhart & Hart Coefficient C	C			$8.7755 \times 10^{-8}$	

### Measurement Conditions / Comments

$T_{LD} = 25^\circ\text{C}$   
 $R_1 / R_2 = e^{\beta(1/T_1 - 1/T_2)}$  at  $T_{LD} = 0^\circ \dots 50^\circ\text{C}$   
 $1/T = A + B(\ln R) + C(\ln R)^3$   
T: temperature in Kelvin  
R: resistance at T in Ohm

# EYP-DFB-0767-00050-1500-BFW01-0002

Revision 0.92

2018-01-19

## SINGLE FREQUENCY LASER DIODES Distributed Feedback Laser

### Pin Assignment

1	Thermoelectric Cooler (+)	14	Thermoelectric Cooler (-)
2	Thermistor	13	Case
3	Photodiode (Anode)	12	not connected
4	Photodiode (Cathode)	11	Laser Diode (Cathode)
5	Thermistor	10	Laser Diode (Anode)
6	not connected	9	not connected
7	not connected	8	not connected

Pins are isolated from case unless noted otherwise.

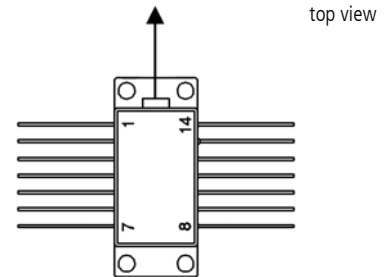

### Package Drawings

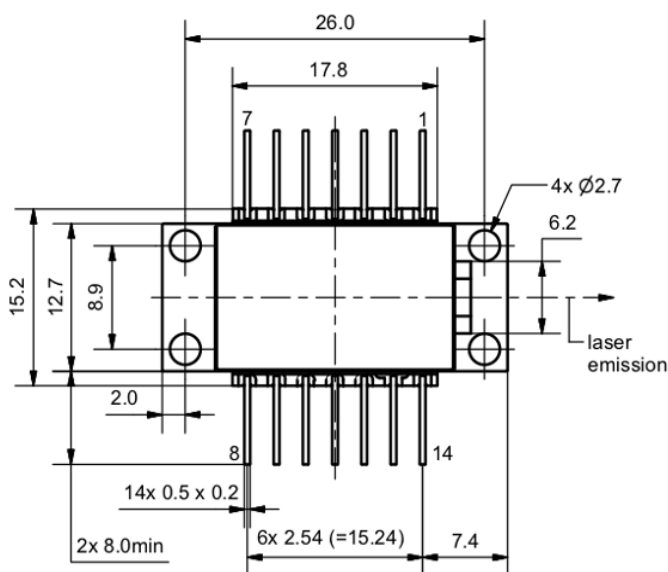
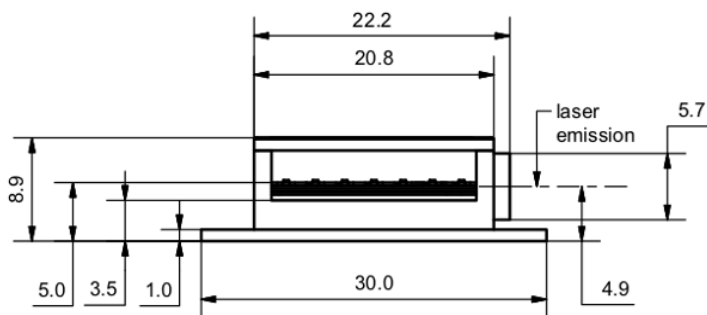

AIZ-15-0729-0947

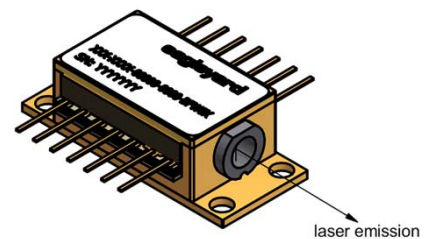

# EYP-DFB-0767-00050-1500-BFW01-0002

Revision 0.92

2018-01-19

## SINGLE FREQUENCY LASER DIODES Distributed Feedback Laser

### Typical Measurement Results

Output Power vs. Current

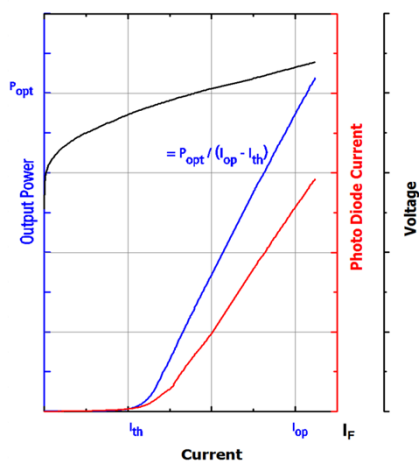

Spectra at Specified Optical Output Power

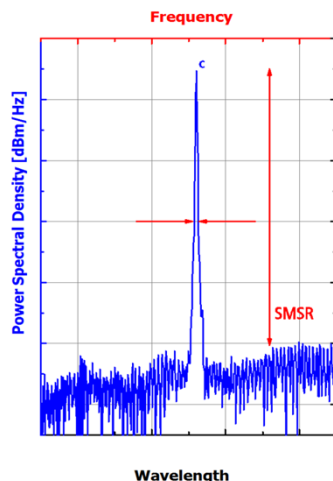

Performance figures, data and any illustrative material provided in this specification are typical and must be specifically confirmed in writing by eagleyard Photonics before they become applicable to any particular order or contract. In accordance with the eagleyard Photonics policy of continuous improvement specifications may change without notice.

Ordering Information:



800 Village Walk #316  
Guilford, CT 06437  
Ph: 203-401-8093

Email orders to: [sales@xsoptix.com](mailto:sales@xsoptix.com)  
Fax orders to: 800-878-7282

### Unpacking, Installation and Laser Safety

Unpacking the laser diodes should only be done at electrostatic safe workstations (EPA). Though protection against electro static discharge (ESD) is implemented in the laser package, charges may occur at surfaces. Please store this product in its original package at a dry, clean place until final use. During device installation, ESD protection has to be maintained.

The DFB laser is sensitive against optical feedback, so an optical isolator may be required in order to avoid any disturbance of the emission spectrum. Operating at moderate temperatures on proper heat sinks will contribute to a long lifetime of the diode.

Avoid direct and/or indirect exposure to the free running beam. Collimating and focussing the free running beam with optics as common in optical instruments will increase threat to the human eye.

Performance figures, data and any illustrative material provided in this specification are typical and must be specifically confirmed in writing by eagleyard Photonics before they become applicable to any particular order or contract. In accordance with the eagleyard Photonics policy of continuous improvement specifications may change without notice.

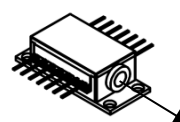

Laser Emission



IEC-60825-0



Complies with 21 CFR 1040.10 and 1040.40

